

HERRAJES DE PUERTAS Y CANCELAS

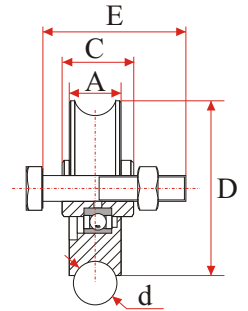

REF.	D (mm)	A (mm)	C (mm)	d (mm)	E	Acab.
PCU8020	78	25	28	20.5	M14x70	Zinc
PCU9020	88	25	30	20.5	M14x70	Zinc
PCU10020	98	25	30	20.5	M14x70	Zinc
PCU12020	118	25	34	20.5	M14x70	Zinc
PCU16020	158	30	45	20.5	M16x75	Zinc



* 2 RODAMIENTOS

REF.	D (mm)	A (mm)	C (mm)	d (mm)	E	Acab.
PCU20020	198	30	44	20.5	M16x75	Zinc

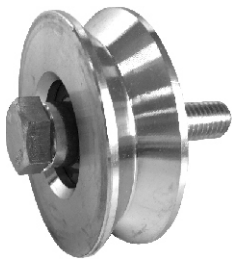
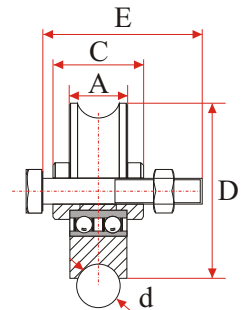

REF.	D (mm)	A (mm)	C (mm)	Canal	E	Acab.
PCV8020	78	20	28	V	M10x55	Zinc
PCV10020	98	22	30	V	M14x70	Zinc
PCV12020	118	25	34	V	M14x70	Zinc

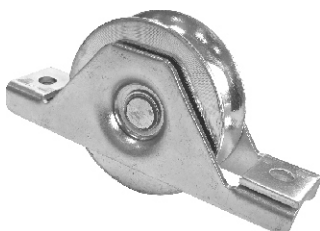
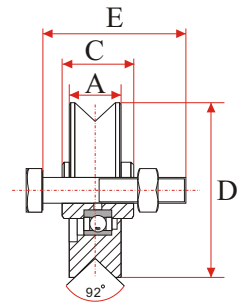

REF.	D (mm)	A (mm)	C (mm)	H (mm)	d (mm)	Acab.
PCUA8020	78	25	32	12	20.5	Zinc
PCUA9020	88	25	33	8	20.5	Zinc
PCUA10020	98	25	33	13	20.5	Zinc
PCUA12020	118	25	36	12	20.5	Zinc

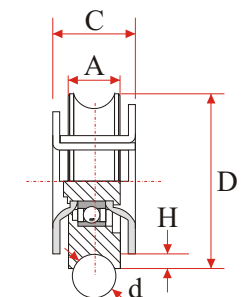

HERRAJES DE PUERTAS Y CANCELAS

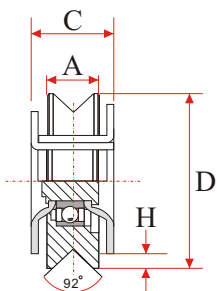

REF.	D (mm)	A (mm)	C (mm)	H (mm)	Acab.
PCVA8020	78	20	32	12	Zinc
PCVA9020	88	20	33	8	Zinc
PCVA10020	98	22	33	13	Zinc
PCVA12020	118	25	36	12	Zinc

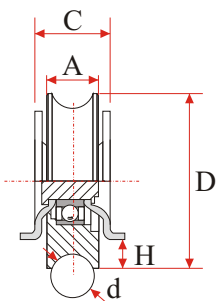
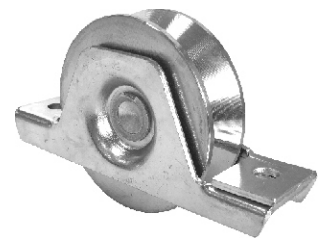

REF.	D (mm)	A (mm)	C (mm)	H (mm)	d (mm)	Acab.
PCUS8020	78	25	30	16	20.5	Zinc
PCUS9020	88	25	30	12	20.5	Zinc
PCUS10020	98	25	30	17	20.5	Zinc
PCUS12020	118	22	32	22	20.5	Zinc

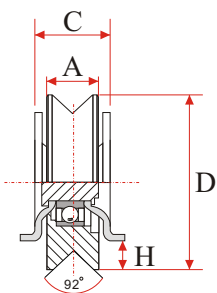
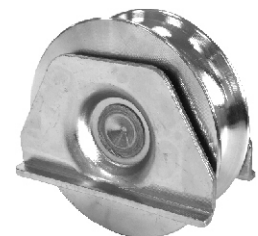

REF.	D (mm)	A (mm)	C (mm)	H (mm)	Acab.
PCVS8020	78	20	29	16	Zinc
PCVS9020	88	20	29	12	Zinc
PCVS10020	98	22	30	17	Zinc
PCVS12020	118	22	32	22	Zinc

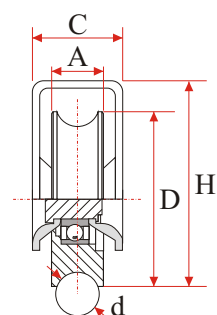

REF.	D (mm)	A (mm)	C (mm)	H (mm)	d (mm)	Acab.
PCUC8020	78	25	35	85	20.5	Zinc
PCUC9020	88	25	36	100	20.5	Zinc
PCUC10020	98	25	36	105	20.5	Zinc



HERRAJES DE PUERTAS Y CANCELAS



* 2 RODAMIENTOS

REF.	D (mm)	A (mm)	C (mm)	H (mm)	d (mm)	Acab.
PCUC12020	118	30	42	127	20.5	Zinc

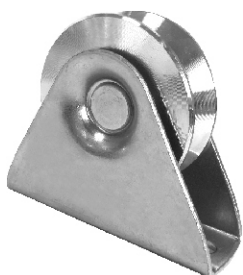
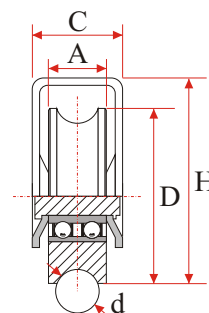

REF.	D (mm)	A (mm)	C (mm)	H (mm)	Acab.
PCVC8020	78	20	35	85	Zinc
PCVC9020	88	20	36	100	Zinc
PCVC10020	98	22	36	105	Zinc

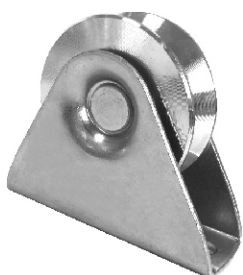
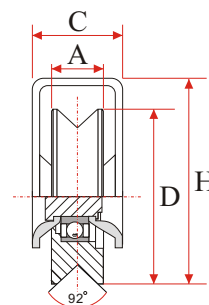

* 2 RODAMIENTOS

REF.	D (mm)	A (mm)	C (mm)	H (mm)	Acab.
PCVC12020	118	30	42	127	Zinc

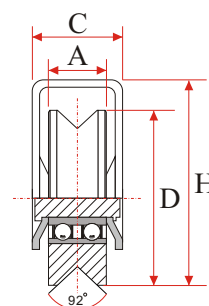

REF.	D (mm)	H1 (mm)	H (mm)	M
RN2540	25	40	75	12
RN3040	30	40	75	14
RN3540	40	44	90	16
RN4060	40	60	104	16

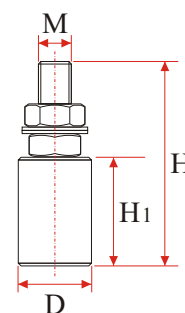

HERRAJES DE PUERTAS Y CANCELAS

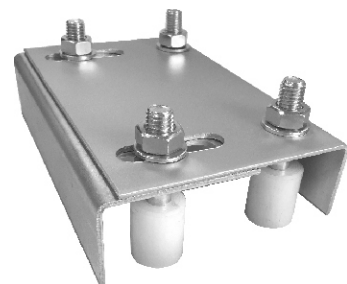
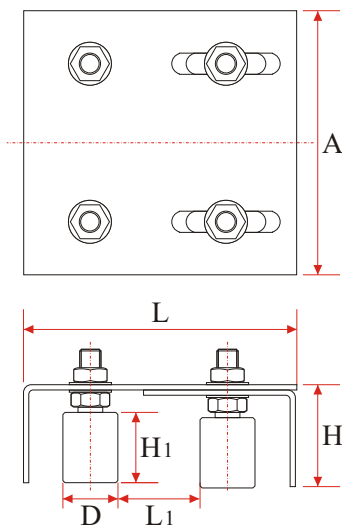

REF.	D (mm)	A (mm)	H1 (mm)	H (mm)	L (mm)	L1 (mm)
CP4RM	30	220	40	55	138-182	27-71
CP4RG	40	350	44	68	176-260	19-103

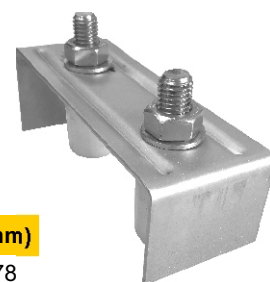
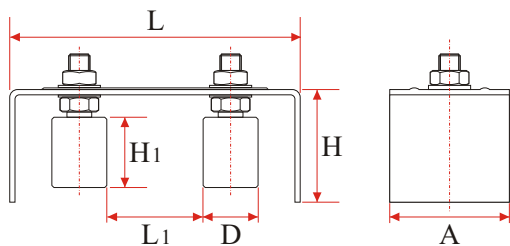

REF.	D (mm)	A (mm)	H1 (mm)	H (mm)	L (mm)	L1 (mm)
CP2RM	30	68	40	64	165	35-78
CP2RG	40	68	44	64	165	31-69

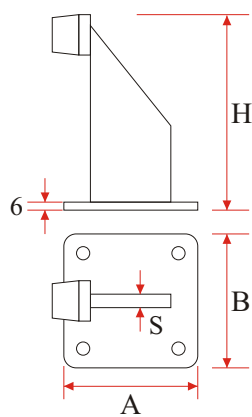

REF.	H (mm)	A (mm)	B (mm)	S (mm)	Acab.
TOA	146	100	100	10	Zinc

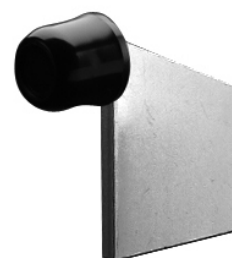
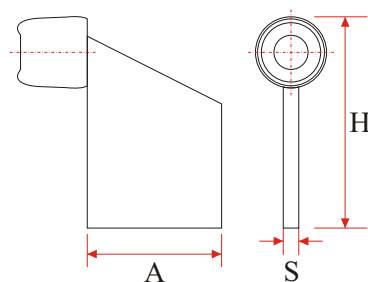

REF.	H (mm)	A (mm)	S (mm)	Acab.
TOS	95	50	8	Zinc

HERRAJES DE PUERTAS Y CANCELAS



*CANAL 20; LARGO 3M

REF.	L (mm)	H (mm)	S (mm)	Acab.
CAE3M	65	60	3.5	Zinc

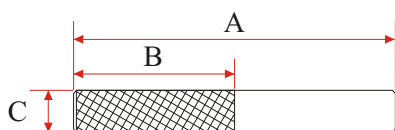
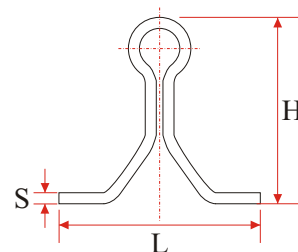

REF.	A (mm)	B (mm)	C (mm)	Acab.
UCA	100	50	13	Zinc

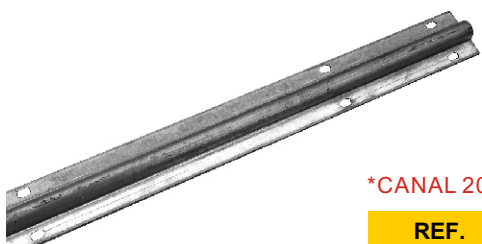
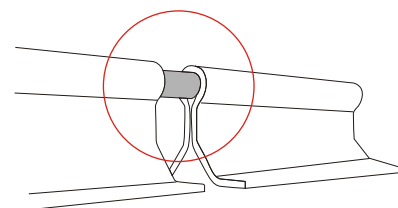

*CANAL 20; LARGO 3M

REF.	L (mm)	H (mm)	S (mm)	A (mm)	B (mm)	Acab.
CAS3M	55	15	3.5	11	6	Zinc

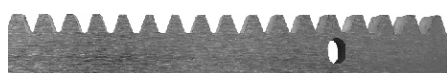
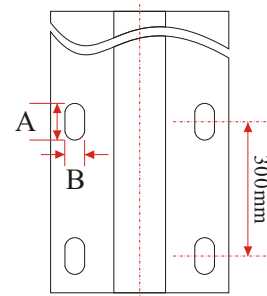
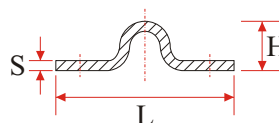

REF.	Módulo	A (mm)	H (mm)	L	Acab.
CRA2M	M.4	12	30	2M	Zinc

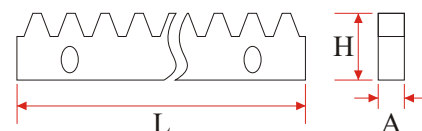

REF.	Módulo	A (mm)	H (mm)	L	Acab.
CRS2M	M.4	22	22	2M	Zinc

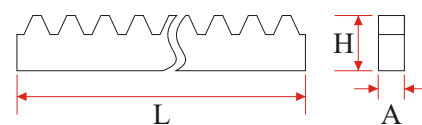

HERRAJES DE PUERTAS Y CANCELAS

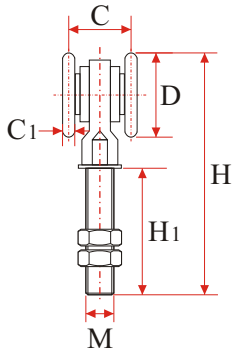

REF.	D (mm)	C (mm)	C1 (mm)	H (mm)	H1 (mm)	M	Acab.
ROS40	33.5	27	4	130	78	10	Zinc

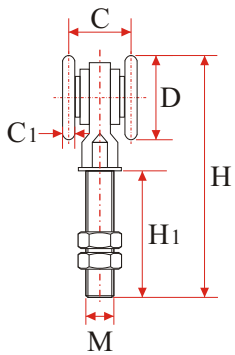

REF.	D (mm)	C (mm)	C1 (mm)	H (mm)	H1 (mm)	M	Acab.
ROD40	33.5	27	4	130	78	10	Zinc

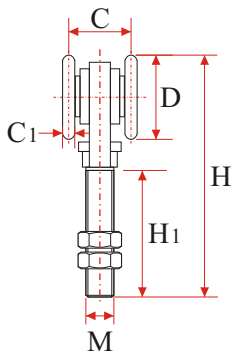
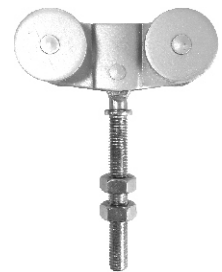

REF.	D (mm)	C (mm)	C1 (mm)	H (mm)	H1 (mm)	M	Acab.
ROS60	47	38	5	167	93	15	Zinc

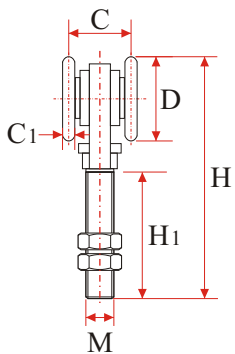

REF.	D (mm)	C (mm)	C1 (mm)	H (mm)	H1 (mm)	M	Acab.
ROD60	47	38	5	167	93	15	Zinc

